

型号: MS31/630

尺寸

G:	Tr 630×6
d ₁ :	730
d ₂ :	685
d ₃ :	800
B:	95
B ₁ :	120
B ₂ :	-
b:	50
h:	28
质量:	125

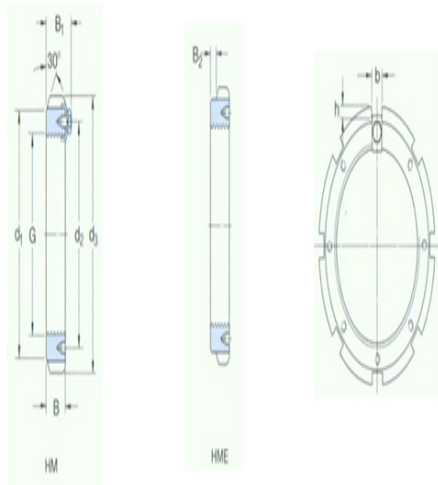

型号

不带锁紧定扣的锁紧螺母	HM31/630
:	
适用锁紧扣:	MS31/630
适用扳手:	TMFN600-750