

型号: MS31/710

尺寸

G:	Tr 710×7
d ₁ :	825
d ₂ :	772
d ₃ :	900
B:	106
B ₁ :	133
B ₂ :	-
b:	55
h:	30
质量:	162

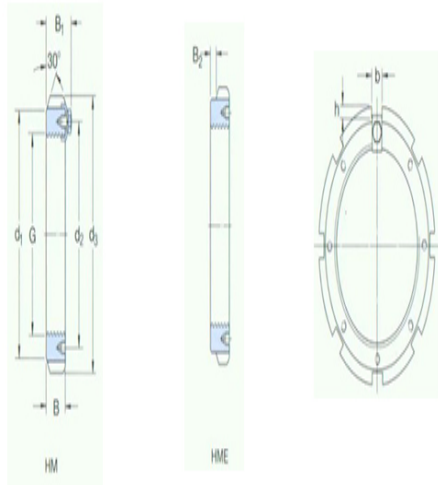

型号

不带锁紧定扣的锁紧螺母	HM31/710
:	
适用锁紧扣:	MS31/710
适用扳手:	TMFN600-750