

型号: MS30/900-850

尺寸

G:	Tr 850×7
d ₁ :	925
d ₂ :	887
d ₃ :	980
B:	90
B ₁ :	115
B ₂ :	-
b:	60
h:	25
质量:	115

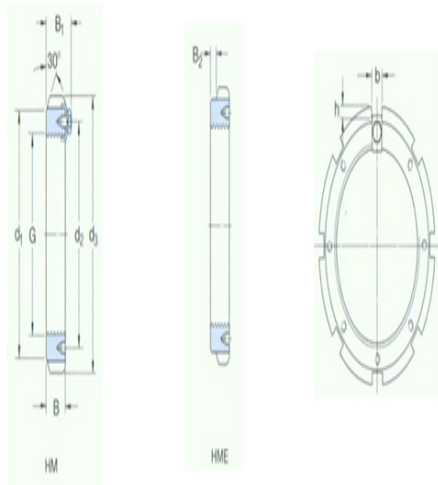

型号

不带锁紧定扣的锁紧螺母	HM30/850
:	
适用锁紧扣:	MS30/900-850
适用扳手:	-