

**型号: SME10GUU**

**参数**

型号:	SME10GUU
轴径:	10
h:	15
E:	18
W:	36
L:	32
F:	23
T:	7
h1:	6
θ:	80
B:	25
C:	20
S:	M5
t:	10
滑行衬套型号:	SM10GUU-OP
动载荷C:	38.0000018049032
静载荷Co:	56.0000026598573
重量:	65

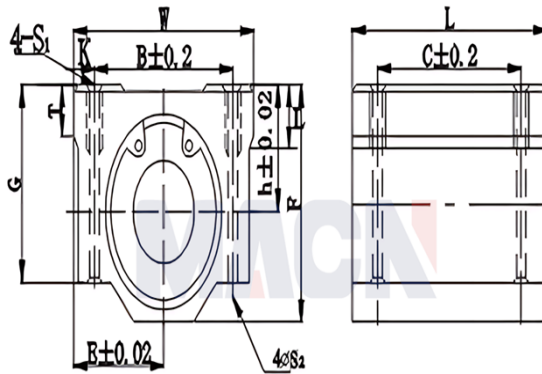

SMA...G

SMA...GUU