

型号: SME30GUU

参数

型号:	SME30GUU
轴径:	30
h:	33
E:	35
W:	70
L:	70
F:	56
T:	15
h1:	14
θ:	50
B:	50
C:	50
S:	M8
t:	18
滑行衬套型号:	SM30GUU-OP
动载荷C:	160.000007599592
静载荷Co:	280.000013299286
重量:	630

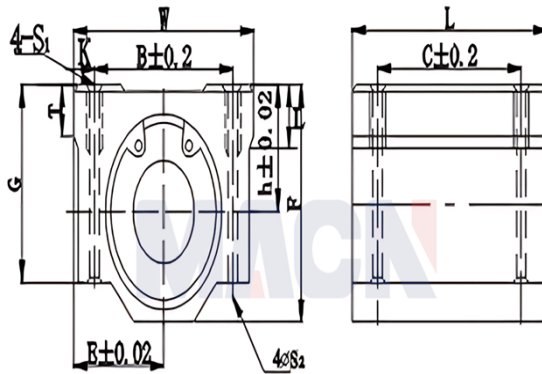

SMA...G

SMA...GUU