

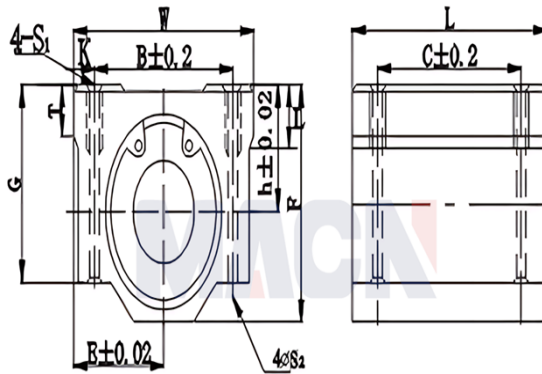

型号: SMA20GUU

参数

型号:	SMA20GUU
轴径:	20
h:	21
E:	27
W:	54
L:	50
F:	41
G:	35
T:	11
B:	40
C:	40
K:	7
S1:	M6
S2:	5.2
t:	12
滑行衬套型号:	SM20GUU
动载荷C:	90.0000042747706
静载荷Co:	140.000006649643
重量:	225



SMA...G

SMA...GUU