

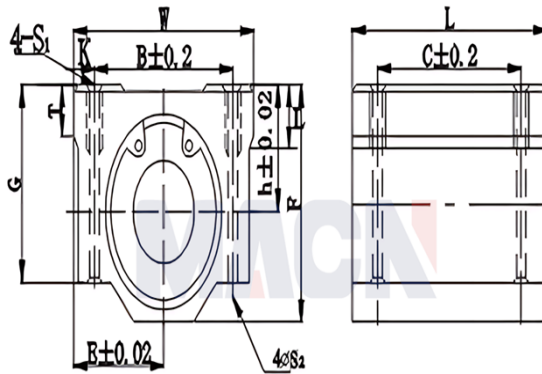

型号: SMA40GUU

参数

型号:	SMA40GUU
轴径:	40
h:	40
E:	51
W:	102
L:	90
F:	78
G:	62
T:	20
B:	80
C:	60
K:	11
S1:	M10
S2:	8.7
t:	25
滑行衬套型号:	SM40GUU
动载荷C:	220.000010449439
静载荷Co:	410.000019473955
重量:	1590



SMA...G

SMA...GUU