

型号: SBR16X940

参数

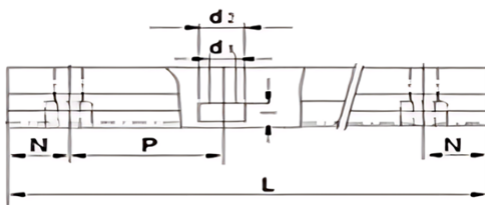
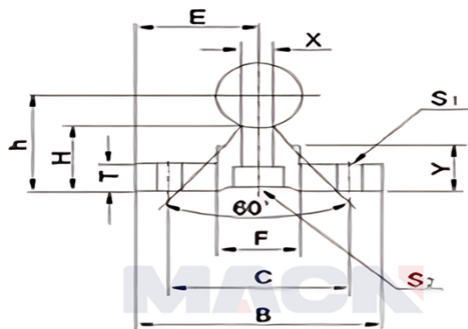
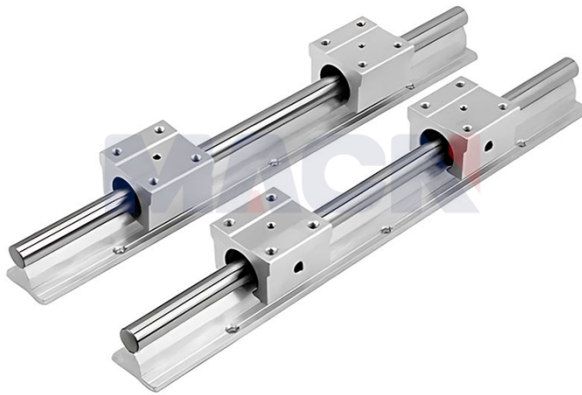

型号:	SBR16X940
轴径尺寸:	φ16
E:	20
h:	25
B:	40
H:	17.8
T:	5
F:	18.5
X:	8
Y:	11.7
C:	30
S1:	φ5.5
S2:	5.5×9.5×5.4
导轨支撑标准长度L:	940
N:	20
P:	150
导轨支撑最大长度:	1390
重量:	1