

型号: SBR30X1450

参数

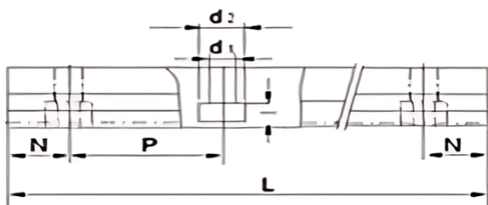
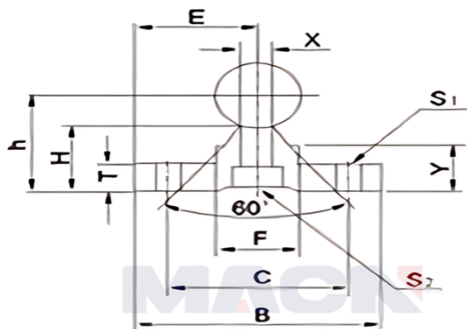
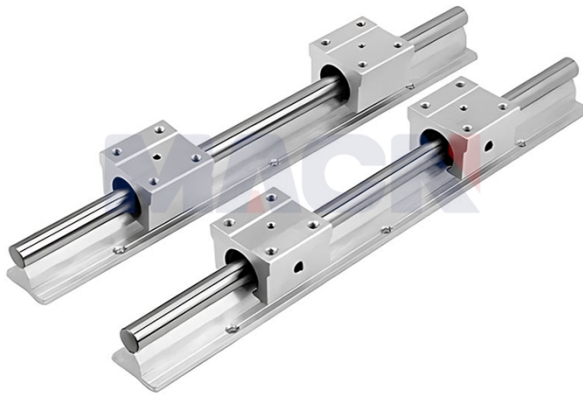

型号:	SBR30X1450
轴径尺寸:	φ30
E:	30
h:	37
B:	60
H:	22.8
T:	7
F:	26.5
X:	10.3
Y:	13
C:	40
S1:	φ6.6
S2:	6.6×11×6.6
导轨支撑标准长度L:	1450
N:	25
P:	200
导轨支撑最大长度:	1850
重量:	1.9