



型号: CRBH4510A

轴径(mm)

: 45

公称型号高刚性型交叉滚子轴承

开放型: CRBH 4510 A

密封型: CRBH 4510 A UU

公称型号高刚性型交叉滚子轴承V

开放型: CRBHV 4510 A

密封型: CRBHV 4510 A UU

质量(参考)

kg: 0.16

主要尺寸(mm)

d: 45

D: 70

B: 10

γ_{\min} : 0.3

相关安装尺寸(mm)

d_a : 51.5

D_a : 63.5

基本额定动负荷C(N)

: 8860

基本额定静负荷 C_0 (N)

: 11300

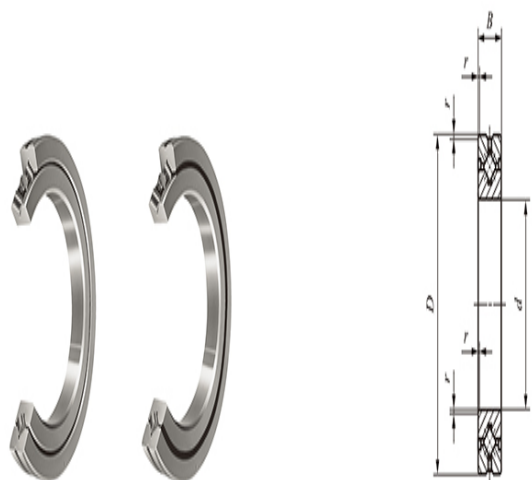

CRBH(V)···A



CRBH(V)···AUU

