

型号: UCP212-36

轴径

d (in.): 21/4

d (mm):

尺寸

H: 2.7480

L: 9.4882

J: 7.2441

A: 2.7559

N: 0.7874

N1: 0.9842

H1: 0.9842

H2: 5.4331

S: 1.0000

B: 2.5630

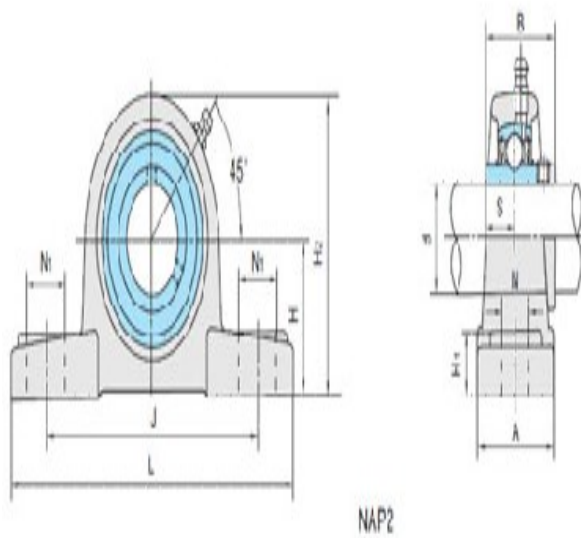

基本代号

基本代号: UCP212-36

螺栓

螺栓: 5/8

轴承代号

轴承代号: UC212-36

座代号

座代号:

重量(kg)(lb)

重量(kg)(lb):