

型号: UCP210

轴径

d (in.):

d (mm):

50

尺寸

H:

57.2

L:

206

J:

159

A:

60

N:

20

N1:

25

H1:

21

H2:

114

S:

19.0

B:

51.6

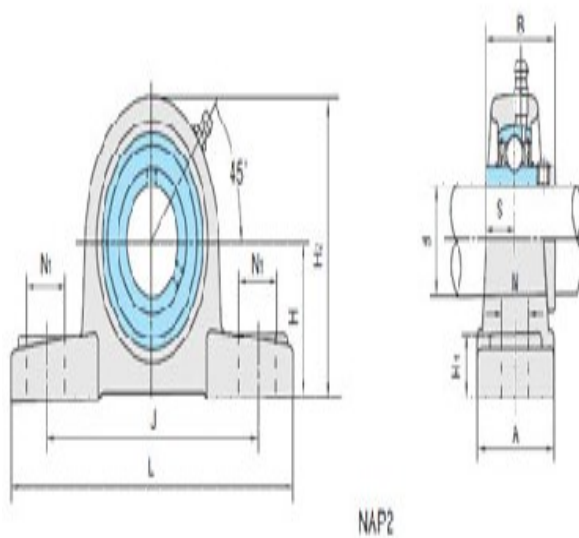

基本代号

基本代号:

UCP210

螺栓

螺栓:

M16

轴承代号

轴承代号:

UC210

座代号

座代号:

P210

重量(kg)(lb)

重量(kg)(lb):

3.10