

型号: UCP207

轴径

d (in.):

d (mm):

35

尺寸

H:

47.6

L:

167

J:

127

A:

48

N:

17

N1:

21

H1:

18

H2:

93

S:

17.5

B:

42.9

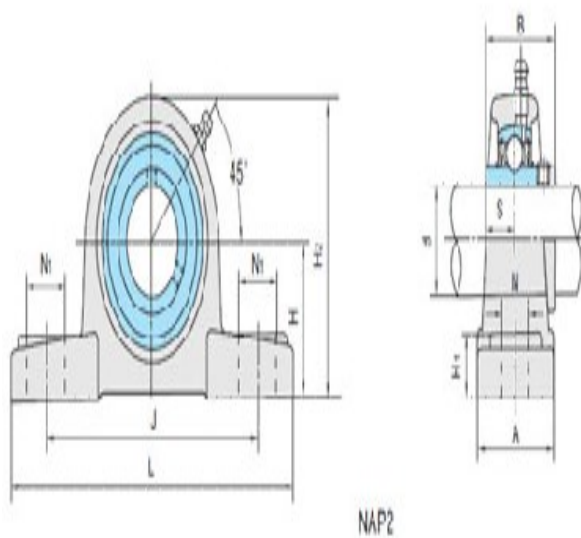

基本代号

基本代号:

UCP207

螺栓

螺栓:

M14

轴承代号

轴承代号:

UC207

座代号

座代号:

P207

重量(kg)(lb)

重量(kg)(lb):

1.72