

型号: UCP205-16

轴径

d (in.): 1

d (mm):

尺寸

H: 1.4370

L: 5.5118

J: 4.1338

A: 1.4961

N: 0.5118

N1: 0.7480

H1: 0.5906

H2: 2.7953

S: 0.5630

B: 1.3425

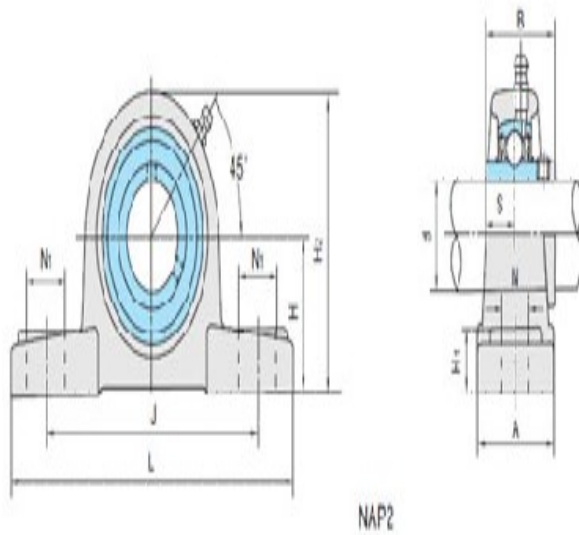

基本代号

基本代号: UCP205-16

螺栓

螺栓: 3/8

轴承代号

轴承代号: UC205-16

座代号

座代号:

重量(kg)(lb)

重量(kg)(lb):