

型号: UCP305-13

轴径

d (in.): 13/16

d (mm):

尺寸

H: 1.7716

L: 6.8898

J: 5.1968

A: 1.7716

N: 0.6693

N1: 0.7874

H1: 0.5906

H2: 3.3464

S: 0.5906

B: 1.4961

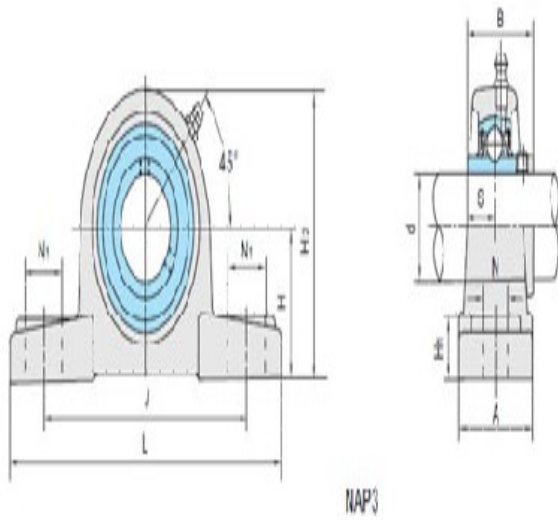

基本代号

基本代号: UCP305-13

螺栓

螺栓: 9/16

轴承代号

轴承代号: UC305-13

座代号

座代号:

重量(kg)(lb)

重量(kg)(lb):